

KLT-OV5645-Y660B V3.1

5MP OmniVision OV5645 MIPI Interface Auto Focus Camera Module

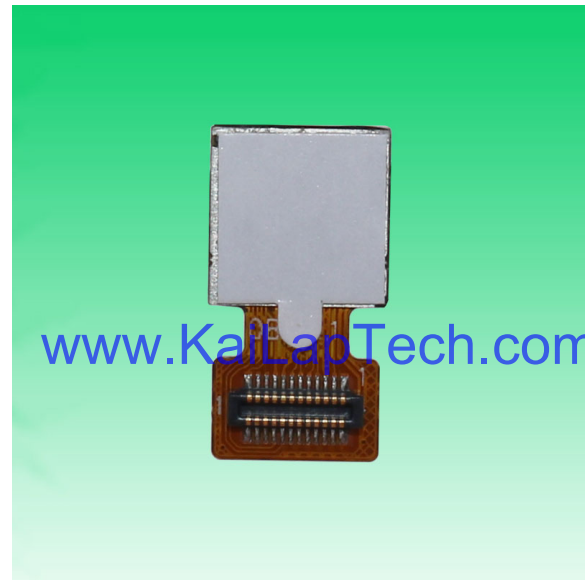

Front View



Back View

Specifications

Camera Module No.	KLT-OV5645-Y660B V3.1
Resolution	5MP
Image Sensor	OV5645
Sensor Type	1/4"
Pixel Size	1.4 um x 1.4 um
EFL	3.29 mm
F.NO	2.80
Pixel	2592 x 1944
View Angle	68.7°(DFOV) 58.1°(HFOV) 45.0°(VFOV)
Lens Dimensions	8.50 x 8.50 x 5.17 mm
Module Size	15.90 x 8.50 mm
Module Type	Auto Focus
Interface	MIPI
Auto Focus VCM Driver IC	Embedded
Lens Model	KLT-LENS-M5101
Lens Type	650nm IR Cut
Operating Temperature	-30°C to +70°C
Mating Connector	BBR43-24KB533



KLT-OV5645-Y660B V3.1

5MP OmniVision OV5645 MIPI Interface Auto Focus Camera Module



Top View



Side View

www.KaiLapTech.com

www.KaiLapTech.com

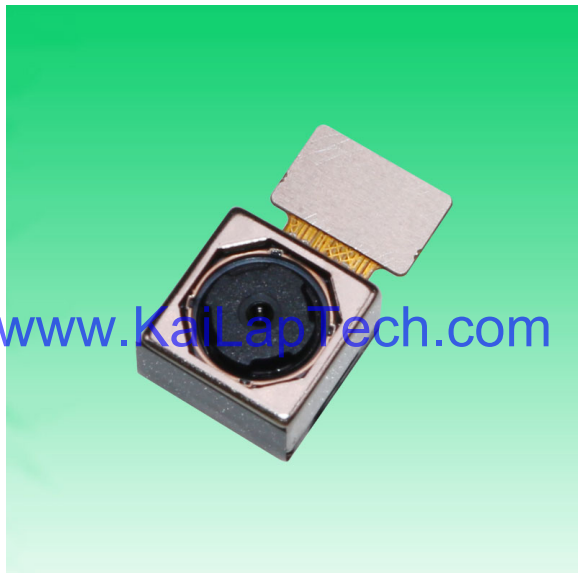

Bottom View



Mating Connector

ROHS

PIN NO	NAME
1	MCLK
2	PWDN
3	GND
4	DATAN0
5	DATAP0
6	CLKN
7	CLKP
8	GND
9	IOVDD(1.8V)
10	AVDD(2.8V)
11	GND
12	RESET
13	SCL
14	SDA
15	GND
16	DATAN1
17	DATAP1
18	AGND
19	NC
20	NC
21	NC
22	DVDD(1.5V)
23	AFVDD(2.8V)
24	NC

焦距 (EFL)	3.29
光圈 (F.NO)	2.8
视场角 (View Angle)	68.7°
畸变 (Distortion)	< 1%
镜头类型 (Lens Size)	1/4 inch
像素 (Array Size)	2592*1944
感光芯片 (Chip Type)	OV5645

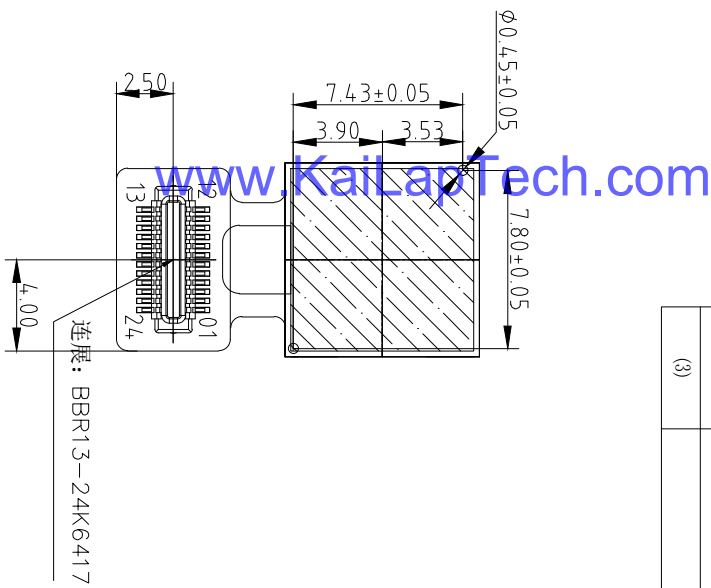
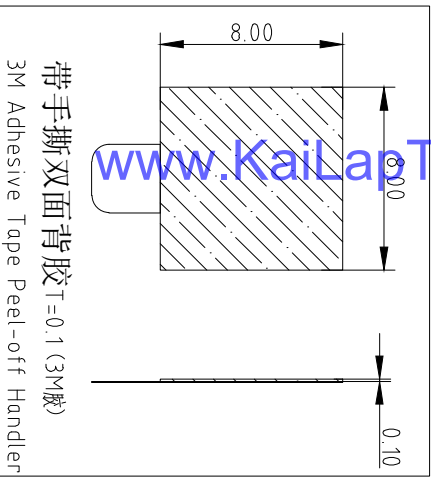
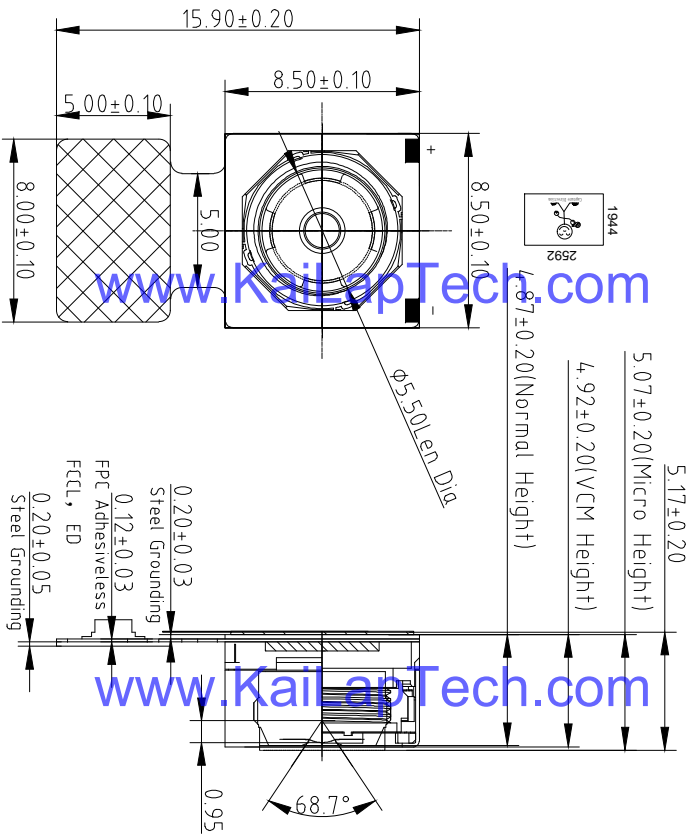

产品变更	详细变更事项
(1)	
(2)	
(3)	

1/0	All	First Release	Kevin	2017-08-11
REV.	Zone	Description	Approved	Date
佳立数码(深圳)有限公司 Kai Lap Technologies Group Ltd				
Designed By:	Kevin	Client Name:	Y660	
Checked By:	Feng Liu	Model Name:	KLT-OV5645-Y660B V3.1	
Approved By:	Aouly_Yan	Projection Type:	Unit:	Material:
		Third Angle	mm	-----
			Scale:	Sheet:
			1:1	1 of 1
				Version:
				1/0



Lens Model: KLT-LENS-M5101

SPECIFICATION		
1. SENSOR SIZE	1/4" (5M CSP)	
2. MAX IMAGE CIRCLE	24.90mm	
3. TOTAL TRACK	4.18±0.1mm	
4. EFL	3.29mm	
5. OPTICAL BFL	1.43mm	
6. MECHANICAL BFL	0.85mm	
7. F/NO	2.8±5%	
8. VIEW OR FIELD DIAGONAL	VERTICAL	45.0° (V=1.38)
	HORIZONTAL	58.1° (V=1.814)
	DIAGONAL	68.7° (V=2.268)
9. OPTICAL DISTORTION	<1.0%	
10. TV DISTORTION	<1.0%	
11. RELATIVE ILLUMINATION	>42.3%	
12. CONSTRUCTION	4P+IR FILTER	
13. CHIP RAY ANGLE	<25°	
14. CUT FREQUENCY AT 50%	650±10nm	
15. THREAD	M6.0X0.35P	
16. IMAGE QUALITY	AXIS	330Lp/mm
	0.7Y	200Lp/mm
17. APPEARANCE QUALITY (Scratch/Dig)	CENTER	20/10
	EDGE	40/20

NO	MODIFY CONTENT	NAME	DATE
1			

ANGLE	RANGE	DIM	UNIT	SCALE
	±0.5°		m	8 : 1
	±0.010		m	8 : 1
	±0.05		m	8 : 1
	±0.1		m	8 : 1

NOTE:

1. 镜头表面不可有油污、灰尘、毛丝等异物。
2. 镜头配VCM锁附高度为 4.7±0.1mm, 扭力为20--60gf.cm。
3. 镜头承受推力为≥2.0kg。
4. 镜头品质参数需符合图中要求。

1 2 3 4 5 6 7 8

REV.	EC#	DESCRIPTION	DATE	DRAWN	CHECKED	APPROVED
A	TJECR10018-02	NEW RELEASE PER NPRI 0009	11/05/10	RAIN	DICK, SON	HARDWARE
B	TJECR13014	AXI, AXI	05/13/13	RAIN	SteveM	eng
						Jeff

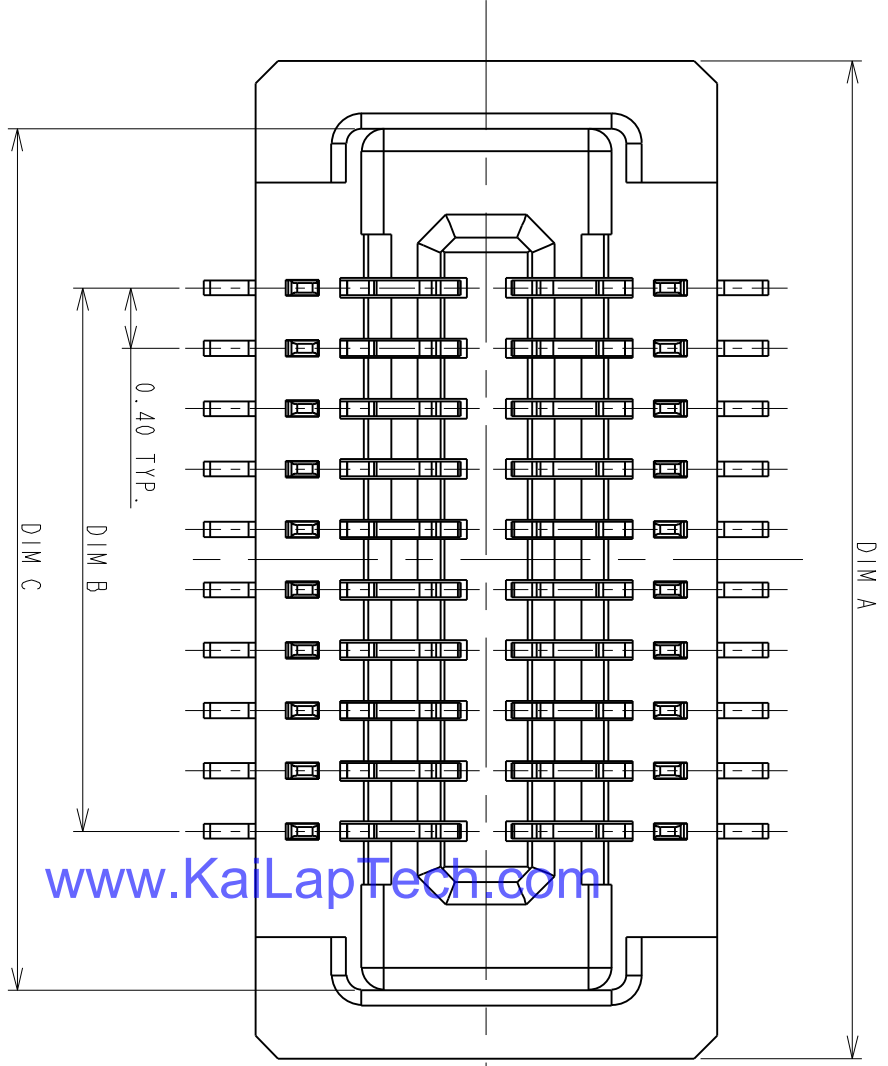

www.KaiLapTech.com

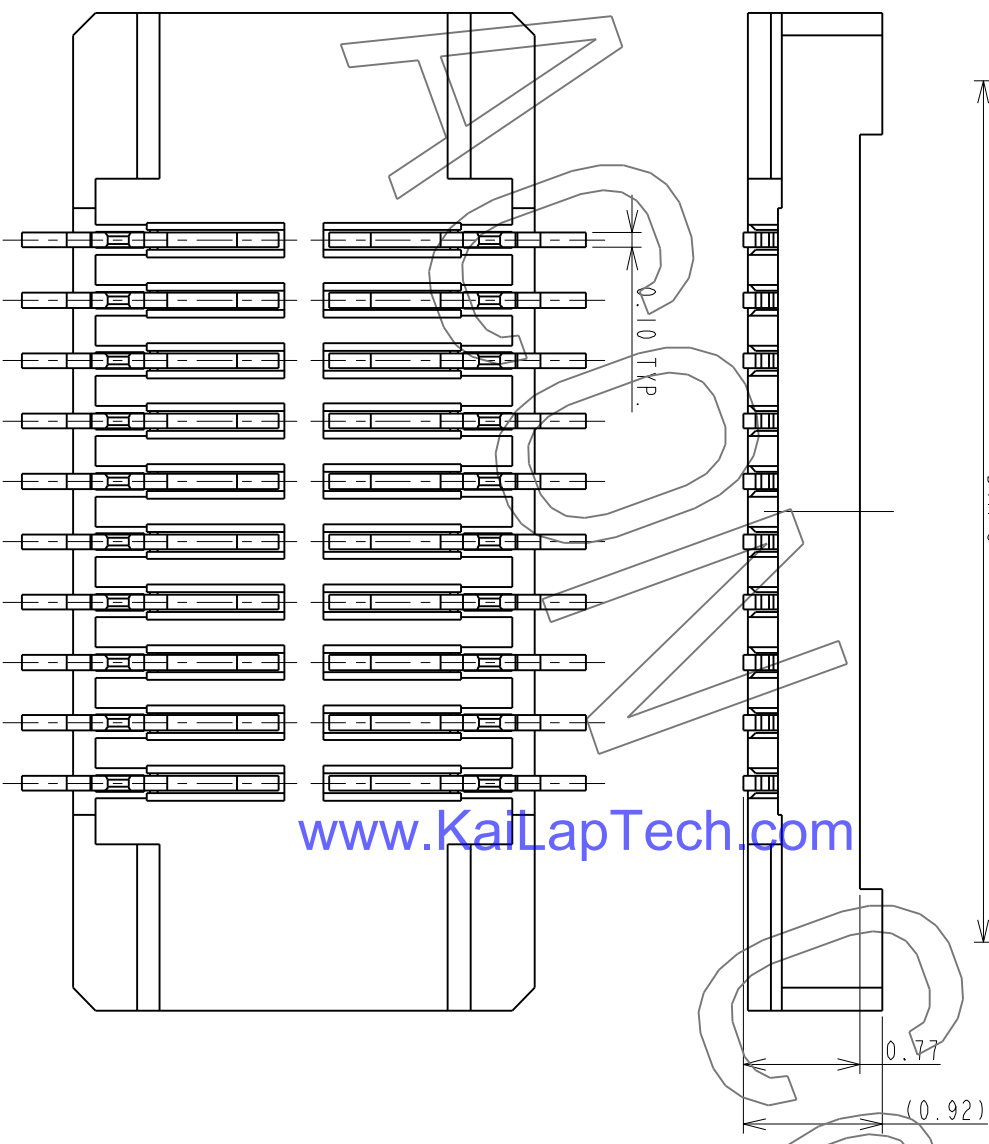

www.KaiLapTech.com

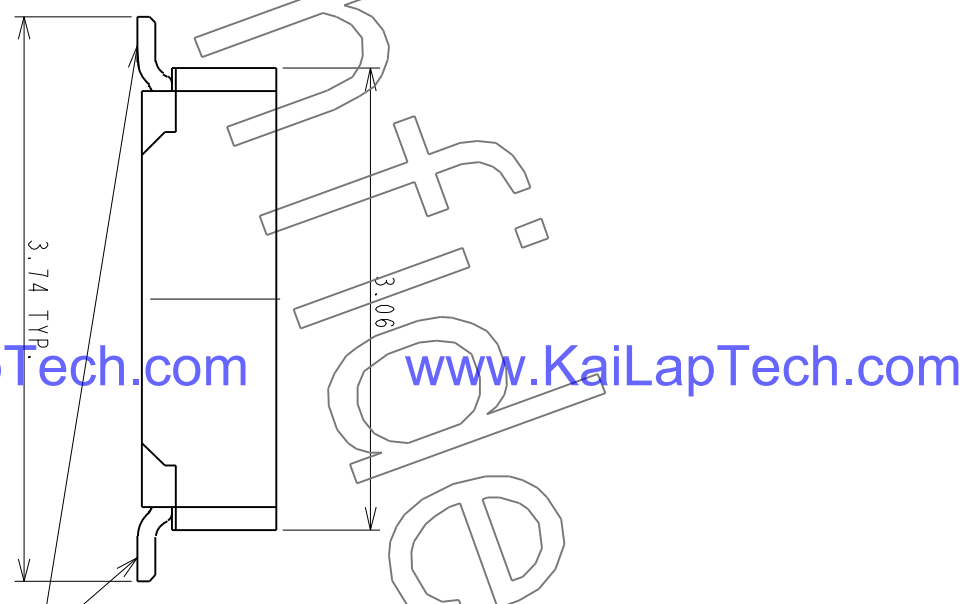

www.KaiLapTech.com

www.KaiLapTech.com

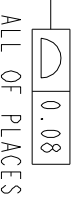
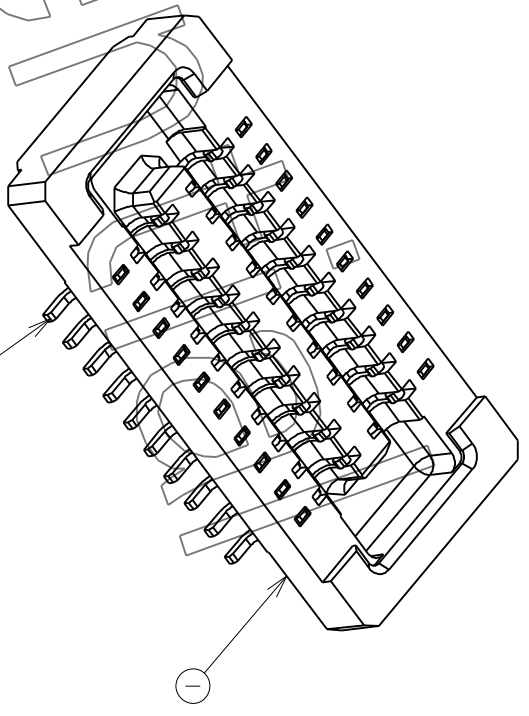

ALL OF PLACES

ITEM	NAME	Q'TY	PART #	MATERIAL / FINISH
2	CONTACT	XX	T-BBR43-100X30	COPPER ALLOY/PLATING GOLD
1	HOUSING	1	I-BBR43-1XXX33	HIGH TEMP RESIN/UL 94 V-0

TOLERANCES UNLESS OTHERWISE SPECIFIED	
GENERAL	±0.38
DESIGN	±0.25
RAIN	±0.05
CHECKED	DATE
HARDWARE	DATE
APPROVED	DATE
DICK, LEE	04/24/10

SCALE	20:1
SHEET	1 OF 2
UNIT	MM

CUSTOMER DRAWING	
SERIES	BBR
DWG NO.	C-BBR43-04-01
SIZE	A3
REV.	B



P0.4*H1.0mm BOARD TO BOARD
CONN. RECEPTACLE
WITHOUT HOLD DOWN

This document and information contained herein are the property of Advanced Connectek Inc. Copies are issued in strict confidence and shall not be reproduced or copied, or used as the basis of manufacture or sale of apparatus without permission.

All materials meet the ACON's spec. environment-related substances management technical standard

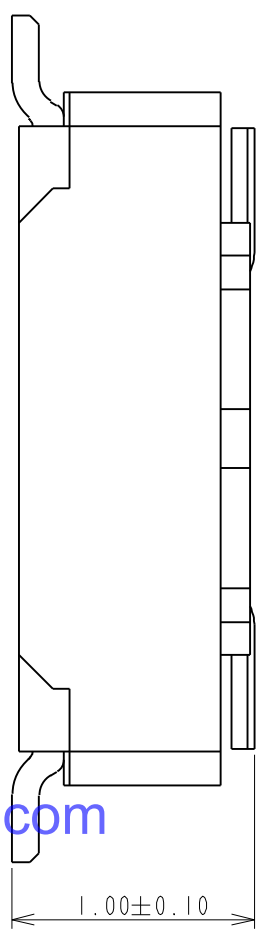

PRODUCT NUMBERING CODE:
 BBR43 - XX K X 5 X X
 1 2 3 4 5 6 7

1. PRODUCTION CODE:
 BBR43: BOARD TO BOARD 0.4 PITCH RECEPTACLE

2. POSITIONS:

XX: POSITIONS(SEE TABLE A

3. INSULATOR COLOR:

K: BLACK

4. CONTACT PLATING:

- 1: GOLD 1u" MIN
- 2: GOLD 5u" MIN
- 3: GOLD 10u" MIN
- B: GOLD 4u" MIN FOR SPOT PLATING
- ALL OVER: NI 50~100u"

5. TYPE OF HEIGHT:

5: H=0.77mm

6. TYPE OF HOLD DOWN:

3: WITHOUT HOLD DOWN

7. OTHER

- 2: WITH POST, FINISHED PRODUCTS
- 3: WITHOUT POST, FINISHED PRODUCTS

www.KaiLapTech.com

www.KaiLapTech.com

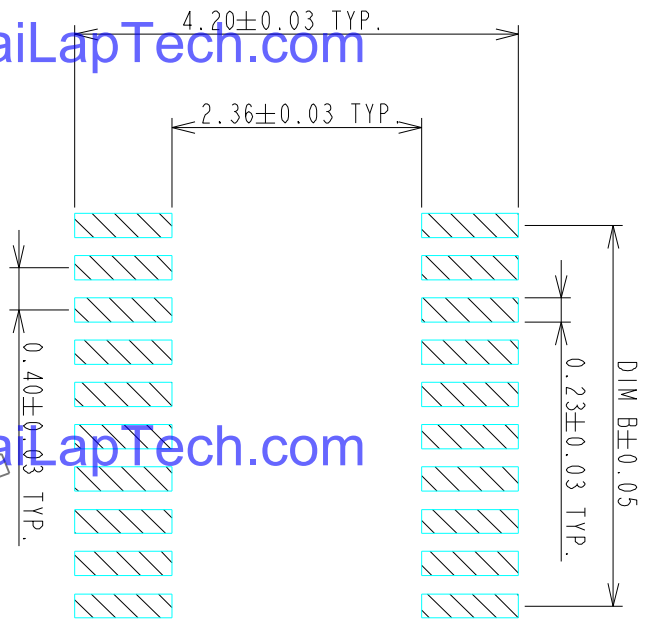

RECOMMENDED P.C. BOARD PATTERN DIMENSION (WITHOUT HOLD DOWN)

www.KaiLapTech.com

www.KaiLapTech.com

www.KaiLapTech.com

www.KaiLapTech.com

NOTES:

- 1.0: RATING
- 1.1: VOLTAGE: 60V AC/DC
- 1.2: CURRENT: 0.5 AMPS
- 1.3: OPERATION TEMPERATURE: -40°C TO +85°C
- 2.0: ELECTRICAL CHARACTERISTIC:
- 2.1: CONTACT RESISTANCE: 50 mΩ MAX INITIAL
- 2.2: INSULATION RESISTANCE: 1000 MΩ MIN INITIAL
- 2.3: DIELECTRIC WITHSTANDING VOLTAGE: 250V AC FOR ONE MINUTE
- 3.0 TOLERANCES UNLESS OTHERWISE SPECIFIED

GENERAL: DIMENSION >10.00 ±0.13
 DIMENSION 5.00~10.00 ±0.10
 DIMENSION <5.00 ±0.05

4.0 ALL COPPLANARITY IS 0.08mm MAX. BEFORE REFLOW

ALL COPPLANARITY IS 0.10mm MAX. AFTER REFLOW

TABLE A:

POSITIONS	DIM A	DIM B	DIM C
10	4.61	1.60	3.71
14	5.41	2.40	4.51
16	5.81	2.80	4.91
18	6.21	3.20	5.31
20	6.61	3.60	5.71
22	7.01	4.00	6.11
24	7.41	4.40	6.51
26	7.81	4.80	6.91
30	8.61	5.60	7.71
32	9.01	6.00	8.11
34	9.41	6.40	8.51
40	10.61	7.60	9.71
44	11.41	8.4	10.51
48	12.21	9.20	11.31
50	12.61	9.60	11.71
54	13.41	10.40	12.51
60	14.61	11.60	13.71
70	16.61	13.60	15.71
80	18.61	15.60	17.71

TOLERANCES UNLESS OTHERWISE SPECIFIED		DRAWN		DATE	
GENERAL X	±0.38	RAIN	04/15/10		
XXX	±0.13	DESIGN			
ANGLES X°	±0.05	RAIN	04/15/10		
SCALE	20:1	CHECKED			
SHEET	2 OF 2	HARDWARE	04/24/10		
UNIT	MM	APPROVED			
		DICK. LEE	04/24/10		
		CUSTOMER DRAWING		TITLE	
		SERIES		P0.4#11.0mm BOARD TO BOARD	
		DWG NO.		CONN. RECEPTACLE	
		C-BBR43-04-01		WITHOUT HOLD DOWN	
		REV.		SIZE	
		B		A3	



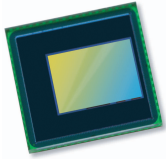

OV5645 5-megapixel product brief



www.KaiLapTech.com

www.KaiLapTech.com

www.KaiLapTech.com

www.KaiLapTech.com

High Quality 5-Megapixel Photography and HD Video for Low-Cost Mobile Devices



available in a lead free package

OmniVision's OV5645 is a high performance, 5-megapixel system-on-chip (SOC) ideally suited for the cost-sensitive segment of the mobile handset market. The CameraChip™ sensor's single MIPI port replaces both a bandwidth-limited DVP interface and a costly embedded JPEG compressor, allowing the new OV5645 sensor to save significant silicon area and cost. An embedded autofocus control with voice coil motor driver offers further cost savings for the end user, making the OV5645 a highly attractive alternative to other 5-megapixel sensors currently on the market.

The OV5645 also features a new picture-in-picture (PIP) architecture that offers an easy-to-implement, low-cost dual camera system solution for mobile handsets and smartphones. The feature is based on a master/slave configuration where a front-facing camera (OV7965) can be connected through the OV5645 master camera, enabling a two-camera system with PIP functionality without the need for an additional MIPI interface into the baseband processor.

Built on OmniVision's 1.4-micron OmniBSI™ pixel architecture, the OV5645 offers high performance 5-megapixel photography and 720p HD video at 60 frames per second (FPS) and 1080p HD video at 30 FPS with complete user control over formatting and output data transfer. The sensor's 720p HD video is captured in full field-of-view with 2 x 2 binning, which doubles the sensitivity and improves the signal-to-noise ratio (SNR). A unique post-binning, re-sampling filter function removes zigzag artifacts around slant edges and minimizes spatial artifacts to deliver even sharper, crisper color images.

Find out more at www.ovt.com.



Applications

- Cellular Phones
- PC Multimedia
- Toys
- Digital Still Cameras

Product Features

- 1.4 μm x 1.4 μm pixel with OmniBSI+™ technology for high performance (high sensitivity, low crosstalk, low noise, improved quantum efficiency)
- optical size of 1/4"
- automatic image control functions: automatic exposure control (AEC), automatic white balance (AWB), automatic band filter (ABF), automatic 50/60 Hz luminance detection, and automatic blacklevel calibration (ABL)
- image quality controls: color saturation, hue, gamma, sharpness (edge enhancement), lens correction, defective pixel canceling, and noise canceling
- support for output formats: RAW RGB, RGB565/555/444, YUV422/420, YCbCr422
- support for video or snapshot operations
- support for internal and external frame synchronization for frame exposure mode
- support for LED and flash strobe mode
- support for horizontal and vertical sub-sampling, binning
- support for minimizing artifacts on binned image
- support for data compression output
- support for anti-shake
- standard serial SCCB interface
- dual lane MIPI output interface
- embedded 1.5V regulator for core power
- programmable I/O drive capability, I/O tri-state configurability
- support for black sun cancellation
- support for images sizes: 5 megapixel, and any arbitrary size scaling down from 5 megapixel
- support for auto focus control (AFC) with embedded AF VCM driver
- embedded microcontroller
- suitable for module size of 8.5 x 8.5 x $\pm 6\text{mm}$ with both CSP and RW packaging

OV5645

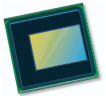

Ordering Information

- OV05645-A66A**
(color, lead-free, 66-pin CSP3)
- OV05645-G04A**
(color, chip probing, 200 μm backgrinding, reconstructed wafer)

Product Specifications

- active array size:** 2592 x 1944
- input clock frequency:** 6 - 27 MHz
- power supply:**
 - core: 1.5V $\pm 5\%$ (with embedded 1.5 regulator)
 - analog AF: 3.0V / 2.8V typical
 - I/O: 1.8V / 2.8V
- temperature range:**
 - operating: -30°C to 70°C junction temperature
 - stable image: 0°C to 50°C junction temperature
- output formats:** 8-/10-bit RGB RAW, RGB565/555/444, YUV422/420, YCbCr422 output
- lens size:** 1/4"
- lens chief ray angle:** 29.1°
- max S/N ratio:** 36 dB
- maximum image transfer rate:**
 - OSXGA (2592x1944): 15 fps
 - 1080p: 30 fps
 - 1280x960: 45 fps
 - 720p: 60 fps
- shutter:** rolling shutter / frame exposure
- maximum exposure interval:** 1964 x t_{row}
- pixel size:** 1.4 μm x 1.4 μm
- image area:** 3673.6 μm x 2738.4 μm
- package/die dimensions:**
 - CSP3: 6200 μm x 4860 μm
 - COB: 6190 μm x 4850 μm

www.KaiLapTech.com

www.KaiLapTech.com

Functional Block Diagram

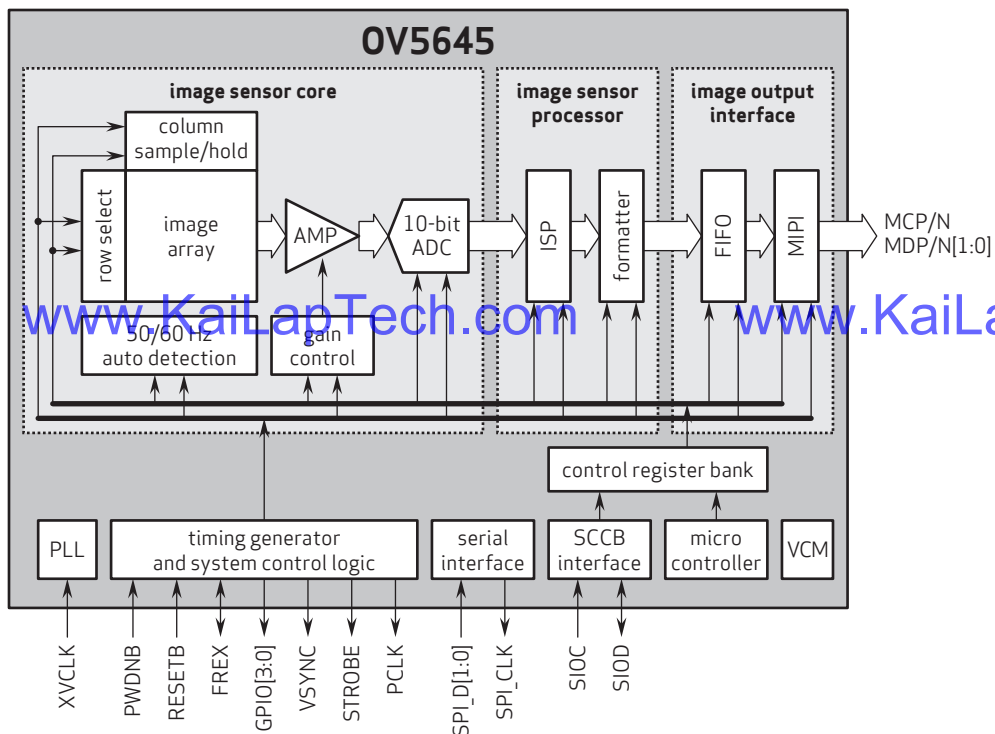

4275 Burton Drive
Santa Clara, CA 95054
USA

Tel: + 1 408 567 3000
Fax: + 1 408 567 3001
www.ovt.com

OmniVision reserves the right to make changes to their products or to discontinue any product or service without further notice. OmniVision, the OmniVision logo and OmniPixel are registered trademarks of OmniVision Technologies, Inc. OmniBSI+ is a trademark of OmniVision Technologies, Inc. All other trademarks are the property of their respective owners.

OmniVision



Camera Module Pinout Definition Reference Chart

OmniVision	Sony	Samsung	On-Semi	Aptina	Himax	GalaxyCore	PixArt	SmartSens	Sensors
Pin Signal		Description							
DGND GND		ground for digital circuit							
AGND		ground for analog circuit							
PCLK DCK		DVP PCLK output							
XCLR PWDN XSHUTDOWN STANDBY		power down active high with internal pull-down resistor							
MCLK XVCLK XCLK INCK		system input clock							
RESET RST		reset active low with internal pull-up resistor							
NC NULL		no connect							
SDA SIO_D SIOD		SCCB data							
SCL SIO_C SIOC		SCCB input clock							
VSYNC XVS FSYNC		DVP VSYNC output							
HREF XHS		DVP HREF output							
DOVDD		power for I/O circuit							
AFVDD		power for VCM circuit							
AVDD		power for analog circuit							
DVDD		power for digital circuit							
STROBE FSTROBE		strobe output							
FSIN		synchronize the VSYNC signal from the other sensor							
SID		SCCB last bit ID input							
ILPWM		mechanical shutter output indicator							
FREQ		frame exposure / mechanical shutter							
GPIO		general purpose inputs							
SLASEL		I2C slave address select							
AFEN		CEN chip enable active high on VCM driver IC							
MIPI Interface									
MDN0 DN0 MD0N DATA_N DMO1N		MIPI 1st data lane negative output							
MDP0 DP0 MD0P DATA_P DMO1P		MIPI 1st data lane positive output							
MDN1 DN1 MD1N DATA2_N DMO2N		MIPI 2nd data lane negative output							
MDP1 DP1 MD1P DATA2_P DMO2P		MIPI 2nd data lane positive output							
MDN2 DN2 MD2N DATA3_N DMO3N		MIPI 3rd data lane negative output							
MDP2 DP2 MD2P DATA3_P DMO3P		MIPI 3rd data lane positive output							
MDN3 DN3 MD3N DATA4_N DMO4N		MIPI 4th data lane negative output							
MDP3 DP3 MD3P DATA4_P DMO4P		MIPI 4th data lane positive output							
MCN CLKN CLK_N DCKN		MIPI clock negative output							
MCP CLKP MCP CLK_P DCKN		MIPI clock positive output							
DVP Parallel Interface									
D0 DO0 Y0		DVP data output port 0							
D1 DO1 Y1		DVP data output port 1							
D2 DO2 Y2		DVP data output port 2							
D3 DO3 Y3		DVP data output port 3							
D4 DO4 Y4		DVP data output port 4							
D5 DO5 Y5		DVP data output port 5							
D6 DO6 Y6		DVP data output port 6							
D7 DO7 Y7		DVP data output port 7							
D8 DO8 Y8		DVP data output port 8							
D9 DO9 Y9		DVP data output port 9							
D10 DO10 Y10		DVP data output port 10							
D11 DO11 Y11		DVP data output port 11							



your **BEST** camera module partner

Cameras Applications



www.KaiLapTech.com



www.KaiLapTech.com



www.KaiLapTech.com

www.KaiLapTech.com



www.KaiLapTech.com



www.KaiLapTech.com





Camera Reliability Test

Reliability Inspection Item			Testing Method	Acceptance Criteria
Category	Item			
Environmental	Storage Temperature	High 60°C 96 Hours	Temperature Chamber	No Abnormal Situation
		Low -20°C 96 Hours	Temperature Chamber	No Abnormal Situation
	Operation Temperature	High 60°C 24 Hours	Temperature Chamber	No Abnormal Situation
		Low -20°C 24 Hours	Temperature Chamber	No Abnormal Situation
	Humidity	60°C 80% 24 Hours	Temperature Chamber	No Abnormal Situation
	Thermal Shock	High 60°C 0.5 Hours Low -20°C 0.5 Hours Cycling in 24 Hours	Temperature Chamber	No Abnormal Situation
Physical	Drop Test (Free Falling)	Without Package 60cm	10 Times on Wood Floor	Electrically Functional
		With Package 60cm	10 Times on Wood Floor	Electrically Functional
	Vibration Test	50Hz X-Axis 2mm 30min	Vibration Table	Electrically Functional
		50Hz Y-Axis 2mm 30min	Vibration Table	Electrically Functional
		50Hz Z-Axis 2mm 30min	Vibration Table	Electrically Functional
Cable Tensile Strength Test	Loading Weight 4 kg 60 Seconds Cycling in 24 Hours	Tensile Testing Machine	Electrically Functional	
Electrical	ESD Test	Contact Discharge 2 KV	ESD Testing Machine	Electrically Functional
		Air Discharge 4 KV	ESD Testing Machine	Electrically Functional
	Aging Test	On/Off 30 Seconds Cycling in 24 Hours	Power Switch	Electrically Functional
	USB Connector	On/Off 250 Times	Plug and Unplug	Electrically Functional





Inspection Item		Inspection Method	Standard of Inspection	
Category	Item			
Appearance	FPC/ PCB	Color	The Naked Eye	Major Difference is Not Allowed.
		Be Torn/Chopped	The Naked Eye	Copper Crack Exposure is Not Allowed.
		Marking	The Naked Eye	Clear, Recognizable (Within 30cm Distance)
	Holder	Scratches	The Naked Eye	The Inside Crack Exposure is Not Allowed
		Gap	The Naked Eye	Meet the Height Standard
		Screw	The Naked Eye	Make Sure Screws Are Presented (If Any)
		Damage	The Naked Eye	The Inside Crack Exposure is Not Allowed
	Lens	Scratch	The Naked Eye	No Effect On Resolution Standard
		Contamination	The Naked Eye	No Effect On Resolution Standard
		Oil Film	The Naked Eye	No Effect On Resolution Standard
		Cover Tape	The Naked Eye	No Issue On Appearance.
	Function	Image	No Communication	Test Board
Bright Pixel			Black Board	Not Allowed In the Image Center
Dark Pixel			White board	Not Allowed In the Image Center
Blurry			The Naked Eye	Not Allowed
No Image			The Naked Eye	Not Allowed
Vertical Line			The Naked Eye	Not Allowed
Horizontal Line			The Naked Eye	Not Allowed
Light Leakage			The Naked Eye	Not Allowed
Blinking Image			The Naked Eye	Not Allowed
Bruise			Inspection Jig	Not Allowed
Resolution			Chart	Follows Outgoing Inspection Chart Standard
Color			The Naked Eye	No Issue
Noise			The Naked Eye	Not Allowed
Corner Dark			The Naked Eye	Less Than 100px By 100px
Color Resolution			The Naked Eye	No Issue
Dimension	Height	The Naked Eye	Follows Approval Data Sheet	
	Width	The Naked Eye	Follows Approval Data Sheet	
	Length	The Naked Eye	Follows Approval Data Sheet	
	Overall	The Naked Eye	Follows Approval Data Sheet	



KLT Package Solutions

KLT Camera Module



Complete with Lens Protection Film

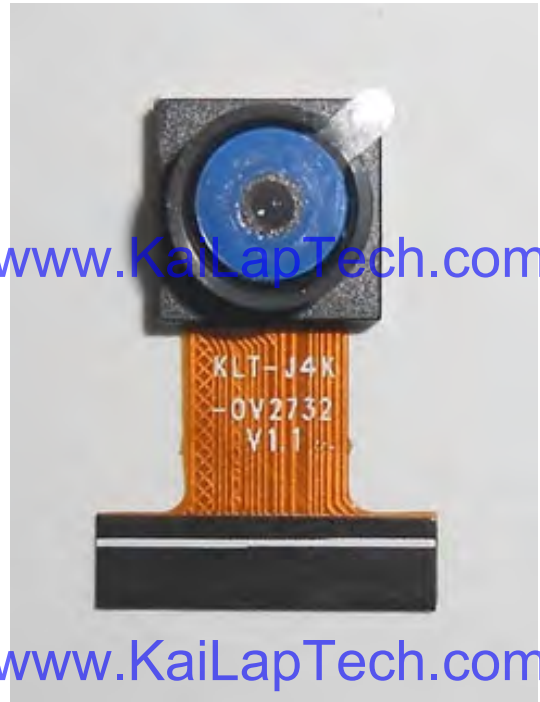

Tray with Grid and Space



Place Cameras on the Tray





Camera Modules Package Solution

Full Tray of Cameras



Cover Tray with Lid



Put Tray into Anti-Static Bag



Vacuum the Anti-Static Bag

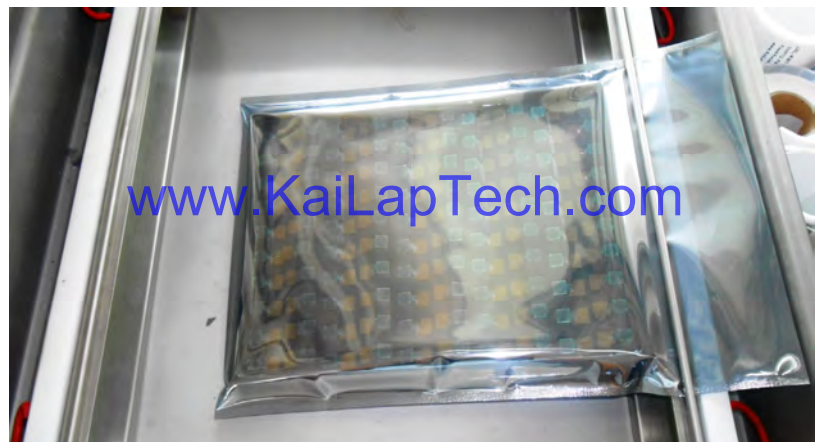



Camera Modules Package Solution

Sealed Vacuum Bag with Labels

- 1. Model and Description 2. Quantity 3. Shipping Date 4. Caution**





CMOS CAMERA MODULES



your BEST camera module partner

Large Order Package Solution

Place Foam Sheets Between Trays

Foam Sheets are Slightly Larger than Trays



www.KaiLapTech.com

www.KaiLapTech.com

Place Foam Sheets and Trays into Box

Foam Sheets are Tightly Fitting Box



www.KaiLapTech.com sales@KaiLapTech.com Tel: (852) 6908 1256 Fax: (852) 3017 6778

All rights reserved @ Kai Lap Technologies Group Ltd. Specifications subject to change without notice.



CMOS CAMERA MODULES



your BEST camera module partner

Small Order Package Solution

Place Foam Sheets and Trays into Small Box



www.KaiLapTech.com

www.KaiLapTech.com

Package in Small Box for Shipment

Foam Sheets are Nicely Fitting the Small Box



www.KaiLapTech.com

www.KaiLapTech.com

Place Small Boxes into Larger Box



www.KaiLapTech.com



www.KaiLapTech.com

Carbon Box Package Solution

Seal the Carbon Box

Final Package Labelled Box



Carbon Box Ready for Shipment

1. Delivery Address and Phone No.
2. Box No. and Ship Date
3. Fragile Caution





Sample Order Package Solution

Place Sample into Small Anti-Static Bag



Place Connectors into Small Ant-Static Bag



Sample Labels on the Small Bag

1. Camera Module or Connector Model
2. Shipping Date and Quantity
3. Caution



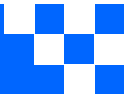

Connectors Large Order Package Solution

Connectors in a Wheel



Label Connectors in the Wheel



The Wheel is Perfectly Fitting the Box



Connectors Box Ready for Shipment



Company Kai Lap Technologies (KLT)

Kai Lap Technologies Group Limited. (KLT) was established in 2009, a next-generation technology driven manufacturer specialized in research, design, and produce of audio and video products. KLT is occupying 20,000 square feet automated plants with 100 employees of annual throughput 30,000,000 units cameras.

KLT provides OEM, ODM design, contract manufacturing, and builds the camera products. You may provide the requirements to us, even with a hand draft, our sales and engineering work together to meet your needs. We consider ourselves your last-term partner in developing practical and innovative solutions.

Our team covers everything from initial concept development to mass produced product. KLT specializes in customized camera design, raw material, electronic engineering, firmware/software development, product testing, and packing design. Our experienced strategic supply systems offer a robust and dependable manufacturing capacity for orders of various sizes.

www.KaiLapTech.com

www.KaiLapTech.com



Limited Warranty

KLT provides the following limited warranty if you purchased the Product(s) directly from KLT company or from KLT's website, www.KaiLapTech.com. Product(s) purchased from other sellers or sources are not covered by this Limited Warranty. KLT guarantees that the Product(s) will be free from defects in materials and workmanship under normal use for a period of one (1) year from the date you receive the product ("Warranty Period").

For all Product(s) that contain or develop material defects in materials or workmanship during the Warranty Period, KLT will, at its sole option, either: (i) repair the Product(s); (ii) replace the Product(s) with a new or refurbished Product(s) (replacement Product(s) being of identical model or functional equivalent); or (iii) provide you a refund of the price you paid for the Product(s).

This Limited Warranty of KLT is solely limited to repair and/or replacement on the terms set forth above. KLT is not reliable or responsible for any subsequent events.





CMOS CAMERA MODULES



your BEST camera module partner

KLT Strength

Powerful Factory



www.KaiLapTech.com

www.KaiLapTech.com

Professional Service



www.KaiLapTech.com

www.KaiLapTech.com

Promised Delivery



www.KaiLapTech.com

www.KaiLapTech.com

www.KaiLapTech.com sales@KaiLapTech.com Tel: (852) 6908 1256 Fax: (852) 3017 6778

All rights reserved @ Kai Lap Technologies Group Ltd. Specifications subject to change without notice.